



# Split System Cooling Product Data

---

**XL20i**  
**4TTZ0024, 036, 048 & 060**  
**with ComfortLink™ II and Charge Assist™**

**2, 3, 4 & 5 Tons**

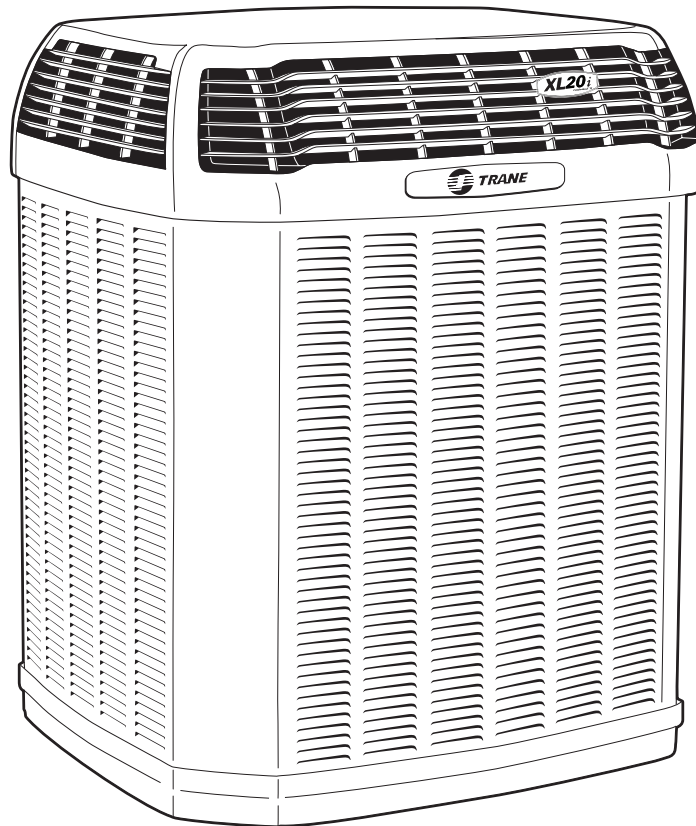

---

**PUB. NO. 22-1825-01**



## Features and Benefits

---

- Two **CLIMATUFF**® compressors
- Efficiency up to **20 SEER**
- All aluminum **SPINE FIN**™ coil
- **WEATHERGUARD**™ II top shields unit
- **WEATHERGUARD**™ fasteners
- **QUICK-SESS**™ cabinet, service access and refrigerant connections with full coil protection
- **DURATUFF**™ base, fast complete drain, weather proof
- **COMFORT-R**™ mode approved
- **COMFORTLINK**™ II system, only two wire control connection
- **CHARGE ASSIST**™ fast/accurate charging every time
- Glossy corrosion resistant finish
- Internal compressor high/low pressure & temperature protection
- Start kit standard
- 50% or 100% capacity modulation
- Compressor sump heat
- Electronic compressor control
- Liquid line filter/drier
- Tarpaulin gray cabinet with anthracite gray top
- Low sound with advanced fan system and compressor sound insulator
- Variable speed fan motor
- XL Seacoast shield
- Service valve cover
- R-410A refrigerant
- S.E.E.T. design testing
- 100% line run test
- Low ambient cooling to 55°F as shipped
- **10-year limited warranty on compressor, coil, and internal functional parts (Residential Use)**
- **Extended warranties available**

# Contents

---

<b>Features and Benefits</b>	<b>2</b>
<b>General Data</b>	<b>4</b>
Product Specifications	4
A-weighted Sound Power Level [dB(A)]	4
Accessory Description and Usage	5
ARI Standard Capacity Rating Conditions	5
<b>Model Nomenclature</b>	<b>6</b>
<b>Electrical Data</b>	<b>7</b>
<b>Dimensions</b>	<b>10</b>
<b>Mechanical Specification Options</b>	<b>11</b>



# General Data

## Product Specifications

Model No. ①	4TTZ0024A1	4TTZ0036A1	4TTZ0048A1	4TTZ0060A1
Electrical Data V/Ph/Hz ②	230/1/60	230/1/60	230/1/60	230/1/60
Min Cir Ampacity	14	19	26	31
Max Fuse Size (Amps)	20	30	40	50
Compressors	2 - CLIMATUFF®	2 - CLIMATUFF®	2 - CLIMATUFF®	2 - CLIMATUFF®
RL AMPS - LR AMPS	8.7 - 58	13.8 - 61.5	18.6 - 93.4	22.8 - 128.7
Outdoor Fan FL Amps	2.80	2.80	2.80	2.80
Fan HP	1/3	1/3	1/3	1/3
Fan Dia (inches)	27.6	27.6	26.6	26.6
Coil	Spine Fin™	Spine Fin™	Spine Fin™	Spine Fin™
Refrigerant R-410A	10/10-LB/OZ	9/13-LB/OZ	15/7-LB/OZ	13/15-LB/OZ
Line Size - (in.) O.D. Gas ③	3/4	3/4	7/8	7/8
Line Size - (in.) O.D. Liquid ③	3/8	3/8	3/8	3/8
Dimensions H x W x D (Crated)	57.4 x 35.1 x 38.7	57.4 x 35.1 x 38.7	57.4 x 35.1 x 38.7	57.4 x 35.1 x 38.7
Weight - Shipping	385	385	470	470
Weight - Net	335	335	420	420
Start Components	YES	YES	YES	YES
Sound Enclosure	YES	YES	YES	YES
Compressor Sump Heat	YES	YES	YES	YES
<b>Optional Accessories: ④</b>				
Rubber Isolator Kit	BAYISLT101	BAYISLT101	BAYISLT101	BAYISLT101
Snow Leg - Base & Cap 4" High	BAYLEGS002	BAYLEGS002	BAYLEGS002	BAYLEGS002
Snow Leg - 4" Extension	BAYLEGS003	BAYLEGS003	BAYLEGS003	BAYLEGS003
Extreme Condition Mounting Kit	BAYECMT023	BAYECMT004	BAYECMT004	BAYECMT004
Vertical Discharge Air Kit Base 4	BAYVDTA003	BAYVDTA004	BAYVDTA004	BAYVDTA004
Auto Charge Solenoid Kit	BAYCAKT001	BAYCAKT001	BAYCAKT001	BAYCAKT001
24 Volt Wiring Harness	BAYACHP024A	BAYACHP024A	BAYACHP024A	BAYACHP024A
Refrigerant Lineset ⑤	TAYREFLN7*	TAYREFLN7*	TAYREFLN3*	TAYREFLN3*

① Certified in accordance with the Air-Source Unitary Heat Pump Equipment certification program which is based on ARI Standard 210/240.

② Calculated in accordance with N.E.C. Only use HACR circuit breakers or fuses.

③ Standard line lengths - 80'. Standard lift - 25' Suction and Liquid line.

For Greater lengths and lifts refer to refrigerant piping software Pub# 32-3312-01. (\*denotes latest revision)

④ For accessory description and usage, see page 5.

⑤ \* = 15, 20, 25, 30, 40 and 50 foot lineset available.

## A-weighted Sound Power Level [dB(A)]

MODEL	SOUND POWER LEVEL [dB(A)]		A-WEIGHTED FULL OCTAVE SOUND POWER LEVEL dB - [dB(A)] High Stage							
	Low Stage Overall	High Stage Overall	63	125	250	500	1000	2000	4000	8000
4TTZ0024A1	59	68	44.8	54.4	60.5	57.7	61.4	61.9	55	49.1
4TTZ0036A1	67	72	50.8	55.3	64.6	67.8	64.3	63.2	57.6	51.5
4TTZ0048A1	68	76	51.3	56	68.3	71.3	65.6	69	58.9	49.6
4TTZ0060A1	70	76	51.4	59.8	67.3	68	69.6	70.1	61	51.5

Note: Tested in accordance with ARI Standard 270.95. (Not listed with ARI)

# General Data

---

## Accessory Description and Usage

**24 Volt Wiring Harness** — Used to wire a communicating outdoor unit to an existing 24 Volt indoor section.

**Charge Assist™ Solenoid Kit** — fast/accurate charging every time.

**Rubber Isolators** — 5 large rubber donuts to isolate condensing unit from transmitting energy into mounting frame or pad. Use on any application where sound transmission needs to be minimized.

**Extreme Condition Mount Kit** — Bracket kits to securely mount condensing unit to a frame or pad without removing any panels. Use in areas with high winds, or on commercial roof tops, etc.

**Low Ambient Cooling** — For low ambient cooling below 55° see Application Guide SSC-APG005-EN.

## ARI Standard Capacity Rating Conditions

### ARI STANDARD 210/240 RATING CONDITIONS —

- (A) Cooling 80°F DB, 67°F WB air entering indoor coil, 95°F DB air entering outdoor coil.
- (B) High Temperature Heating 47°F DB, 43°F WB air entering outdoor coil, 70°F DB air entering indoor coil.
- (C) Low Temperature Heating 17°F DB, 15°F WB air entering outdoor coil, 70°F DB air entering indoor coil.
- (D) Rated indoor airflow for heating is the same as for cooling.

**ARI STANDARD 270 RATING CONDITIONS** — (Noise rating numbers are determined with the unit in cooling operation.) Standard Noise Rating number is at 95°F outdoor air.



ARI Standard  
210/240 UAC





# Model Nomenclature

## Outdoor Units

4 T T Z 0 0 3 6 A 1 0 0 0 A A

- Refrigerant Type**
  - 2 = R-22
  - 4 = R-410A
- TRANE**
- Product Type**
  - W = Split Heat Pump
  - T = Split Cooling
- Product Family**
  - Z = Leadership – Two Stage
  - X = Leadership
  - R = Replacement/Retail
  - B = Basic
  - A = Light Commercial
- Family SEER**
  - 0 = 10    3 = 13    6 = 16
  - 1 = 11    4 = 14    8 = 18
  - 2 = 12    5 = 15    9 = 19
- Split System Connections 1-6 Tons**
  - 0 = Brazed
- Nominal Capacity in 000s of BTUs**
- Major Design Modifications**
- Power Supply**
  - 1 = 200-230/1/60 or 208-230/1/60
  - 3 = 200-230/3/60
  - 4 = 460/3/60
- Secondary Function**
- Minor Design Modifications**
- Unit Parts Identifier**

## Gas Furnaces

T U D 2 B 0 8 0 A C V 3 2 A A

- Furnace Configuration**
  - TU = Upflow/Horizontal
  - TD = Downflow/Horizontal
- Type**
  - E = 80% Induced Draft Standard
  - D = 80% Induced Draft Premium
  - C = 90% Condensing Standard
  - X = 90% Condensing Premium
  - H = 95% Condensing Premium
- Number of Heating Stages**
  - 1 = Single Stage
  - 2 = Two Stage
  - 3 = Three Stage
- Cabinet Width**
  - A = 14.5" Cabinet Width
  - B = 17.5" Cabinet Width
  - C = 21.0" Cabinet Width
  - D = 24.5" Cabinet Width
- Heating Input**
  - 080 = 80,000 MBTUH
- Major Design Change**
- Voltage**
  - 9 = 115 Volts / 60 Hertz / Natural Gas
  - A = 115 Volts / 50 Hertz / Natural Gas
  - C = 115 Volts / Natural Gas with Communicating System Control
  - F = 115 Volts / Natural Gas with Integrated Electronic Filter
  - D = 115 Volts / Natural Gas with Communicating System Control and Integrated Electronic Filter
- Air Capacity for Cooling**
  - 36 = 3 Ton Standard PSC Motor
  - H3 = 3 Ton High Efficiency Motor
  - V3 = 3 Ton Variable Speed Motor
- Draft Inducer Speeds**
  - 1 = Single Speed
  - 2 = Two Speed
  - V = Variable Speed
- Minor Design Change**
- Service Digit - Not Orderable**

## Air Handlers – Residential

4 T E E 3 C 0 5 A 1 0 0 0 A A

- Refrigerant Type**
  - 4 = R-410A
  - 2 = R-22
- Application**
  - TE = Fully Convertible
  - TG = Semi Convertible
  - TF = Front Return
  - TV = Vertical
- Product Family**
  - E = Leadership – Variable Speed
  - P = Leadership
  - C = Replacement/Retail
  - B = Basic
- Flow Control**
  - 3 = Nonbleed TXV
  - 4 = FCCV\*
- Feature Identifier**
  - 0 = Standard Unit
  - F = Air-Tite™
  - D = Integrated Whole House Air Cleaner
  - C = Communicating Air Cleaner
- Model Number Distinguisher**
- Major Design Modifications**
- Power Supply**
  - 1 = Single Phase
- Electrical Connection**
  - 0 = Pig Tails
  - B = Circuit Breaker
  - D = Pull Disconnect
- Future Option – Factory Installed Heater Nominal KW Value**
- Minor Design Modifications**
- Unit Parts Identifier**

## Coils – Residential

4 T X C B 0 0 1 C C 3 H C A A

- Refrigerant Type**
  - 4 - R410A
- Product Family**
  - T-Premium (Heat Pump or Convertible Coil)
- Coil Design**
  - X - Direct Expansion Evaporator Coil
- Product Family**
  - C - Cased A Coil
  - A - Uncased A Coil
  - F - Cased Horizontal Flat Coil
- Coil Width (Cased/Uncased)**
  - A - 14.5" / 13.3"
  - B - 17.5" / 16.3"
  - C - 21.0" / 19.8"
  - D - 24.5" / 23.3"
  - H - 10.5"
- Refrigerant Line Coupling**
  - 0 - Brazed
- Model Number Distinguisher**
- Major Design Change**
- Efficiency**
  - C - Standard
  - S - Hi Efficiency (Derived from 10 SEER products)
- Refrigerant Control**
  - 3 - TXV - Non-Bleed
- Coil Circuitry**
  - H - Heat Pump
- Airflow Configuration**
  - A - Upflow Only
  - U - Upflow / Downflow
  - H - Horizontal Only
  - C - Convertible - Upflow, Downflow, Left or Right Airflow
- Minor Design Change**
- Unit Parts Identifier**

NOTE: There will be a phase-in of new model numbers for new air handlers over next 2 years.  
\*Shipped with R-22 FCCV

# Electrical Data

## Schematic Diagrams

(SEE LEGEND)

### 4TTZ0024, 4TTZ0036, 4TTZ0048, 4TTZ0060

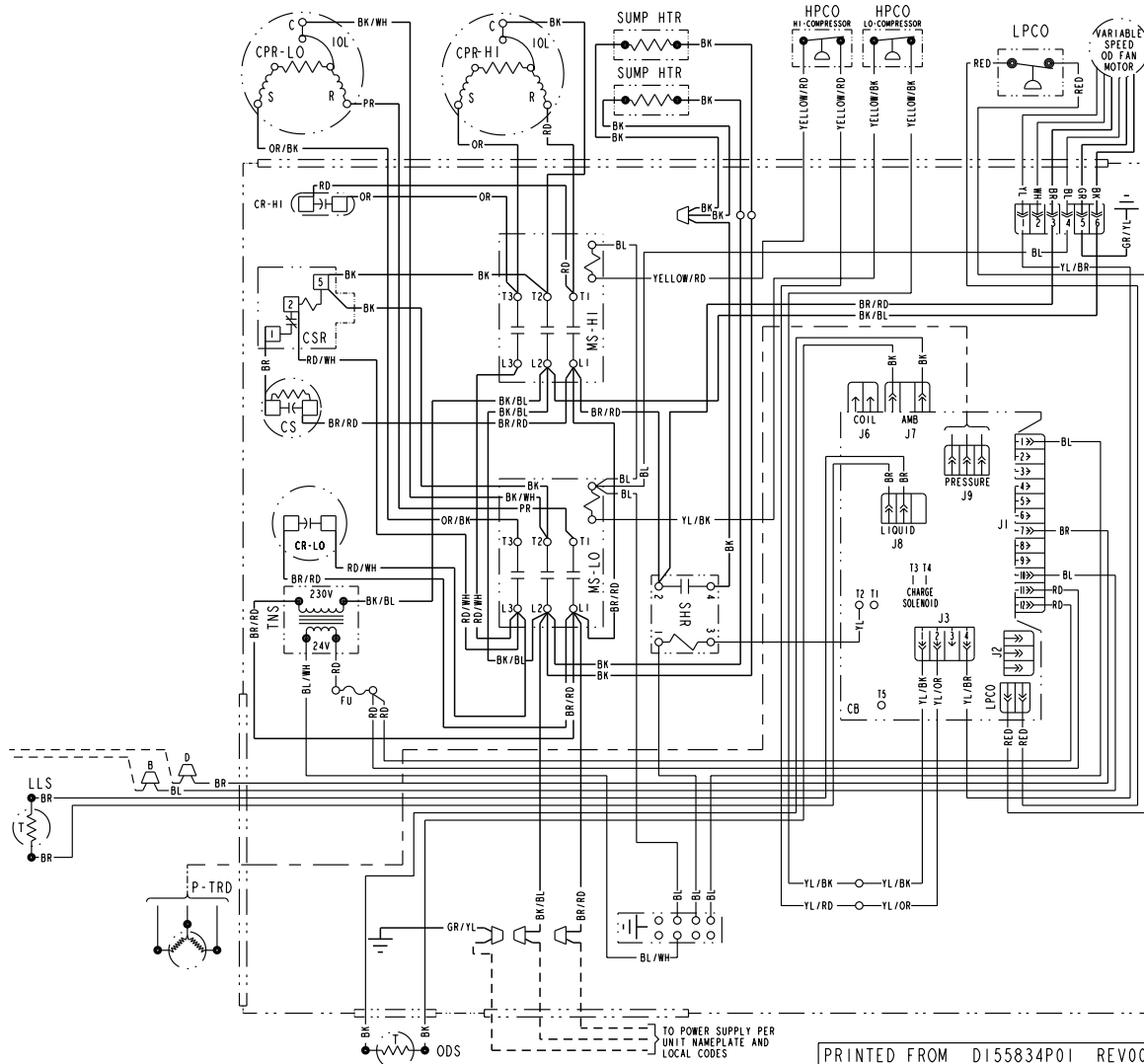



# Electrical Data

## Schematic Diagrams (SEE LEGEND)

### 4TTZ0024, 4TTZ0036, 4TTZ0048, 4TTZ0060

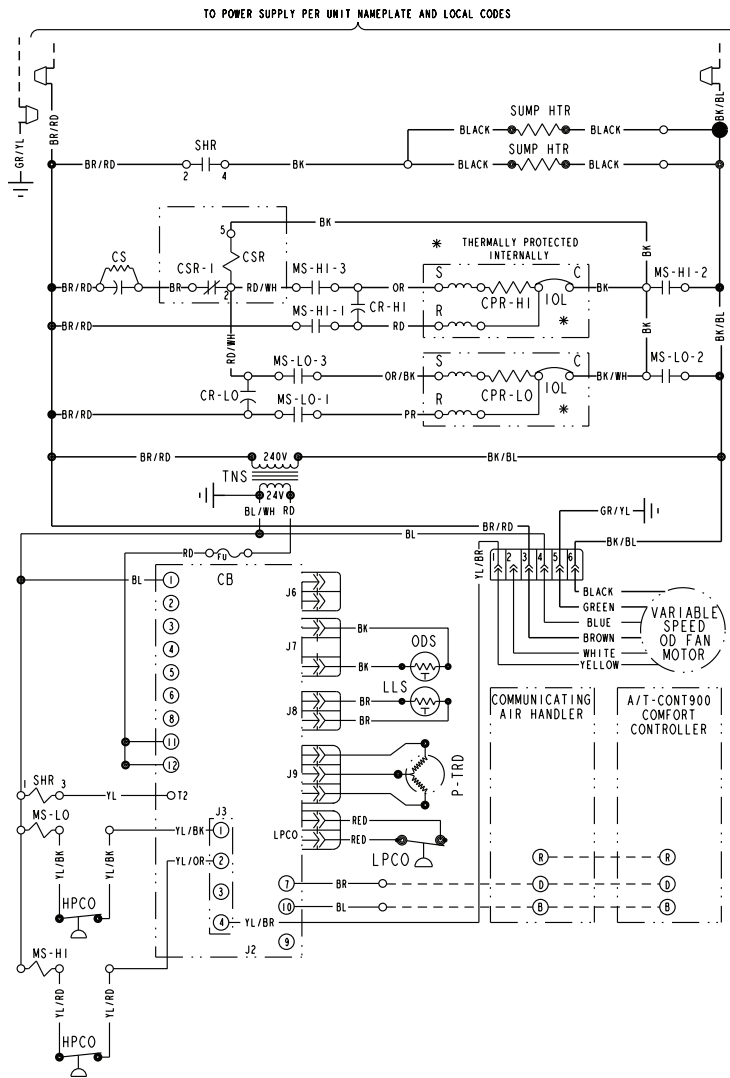

CA	COOLING ANTICIPATOR	LPCO	LOW PRESSURE CUTOFF SW.
CB	CONTROL BOARD	MS	COMPRESSOR MOTOR CONTACTOR
CBS	COIL BOTTOM SENSOR	ODA	OUTDOOR ANTICIPATOR
CF	FAN CAPACITOR	OFT	OUTDOOR FAN THERMOSTAT
CN	WIRE CONNECTOR	ODS	OUTDOOR TEMPERATURE SENSOR
CPR	COMPRESSOR	ODT	OUTDOOR THERMOSTAT
CR	RUN CAPACITOR	P-TRD	PRESSURE TRANSDUCER
CS	STARTING CAPACITOR	RHS	RESISTANCE HEAT SWITCH
CSR	CAPACITOR SWITCHING RELAY	SC	SWITCHOVER VALVE SOLENOID
DFC	DEFROST CONTROL	SHR	SUMP HEAT RELAY
F	INDOOR FAN RELAY	SM	SYSTEM "ON-OFF" SWITCH
FU	FUSE	TDL	DISCHARGE LINE THERMOSTAT
HA	HEATING ANTICIPATOR	TNS	TRANSFORMER
HPCO	HIGH PRESSURE CUTOFF SW.	TS	HEATING-COOLING THERMOSTAT
IOL	INTERNAL OVERLOAD PROTECTOR	TSH	HEATING THERMOSTAT
LLS	LIQUID LINE SENSOR		

**WARNING**  
HAZARDOUS VOLTAGE!  
DISCONNECT ALL ELECTRIC POWER INCLUDING REMOTE DISCONNECTS BEFORE SERVICING.  
FAILURE TO DISCONNECT POWER BEFORE SERVICING CAN CAUSE SEVERE PERSONAL INJURY OR DEATH!

**CAUTION**  
USE COPPER CONDUCTORS ONLY!  
UNIT TERMINALS ARE NOT DESIGNED TO ACCEPT OTHER TYPES OF CONDUCTORS.  
FAILURE TO DO SO MAY CAUSE DAMAGE TO THE EQUIPMENT!

**LEGEND - COLOR OF WIRE**  
BK/BL BLACK WIRE WITH BLUE MARKER  
COLOR OF MARKER

**LEGEND - COLOR OF MARKER**  
BK BLACK OR ORANGE YL YELLOW  
BL BLUE RD RED GR GREEN  
BR BROWN WH WHITE PR PURPLE

NOTES:  
1. LOW VOLTAGE FIELD WIRING MUST BE 18 AWG MIN.

**NOTE**  
THREE PHASE MOTOR (S) FACTORY SUPPLIED IN THIS EQUIPMENT PROTECTED UNDER PRIMARY SINGLE-PHASE CONDITIONS.



**LEGEND-EQUIPMENT DIAGRAM**

—	LOW V.	} FACTORY WIRING
---	LINE V.	
---	LOW V.	} FIELD WIRING
---	LINE V.	
⊥	GROUND	
•	JUNCTION	
△	WIRE NUT OR CONNECTOR	
⌒	COIL	
⌒	CAPACITOR	
⌒	RELAY CONTACT (N.O.)	
⌒	RELAY CONTACT (N.C.)	
⌒	THERMISTOR	
⌒	INTERNAL OVERLOAD PROTECTOR	
⌒	PRESSURE ACTUATED SWITCH	
⌒	TEMP. ACTUATED SWITCH	
⌒	POL. PLUG FEMALE HOUSING (MALE TERM.)	
⌒	POL. PLUG MALE HOUSING (FEMALE TERM.)	
⌒	RESISTOR OR HEATING ELEMENT	
⌒	MOTOR WINDING	
○	TERMINAL	





















# Electrical Data

## Schematic Diagrams

### LEGEND

	COLOR OF WIRE				
BK/BL	BLACK WIRE WITH BLUE MARKER				
	COLOR OF MARKER				
BK	BLACK	OR	ORANGE	YL	YELLOW
BL	BLUE	RD	RED	GR	GREEN
BR	BROWN	WH	WHITE	PR	PURPLE

### SYMBOLS

	24 V.	}	FACTORY WIRING
	LINE V.		
	24 V.	}	FIELD WIRING
	LINE V.		
	GROUND		
	JUNCTION		
	WIRE NUT OR CONNECTOR		
	COIL		
	CAPACITOR		
	RELAY CONTACT (N.O.)		
	RELAY CONTACT (N.C.)		
	THERMISTOR		
	INTERNAL OVERLOAD PROTECTOR		
	PRESSURE ACTUATED SWITCH		
	TEMP. ACTUATED SWITCH		
	POL. PLUG FEMALE HOUSING (MALE TERM.)		
	POL. PLUG MALE HOUSING (FEMALE TERM.)		
	RESISTOR OR HEATING ELEMENT		
	MOTOR WINDING		
	TERMINAL		

CA	COOLING ANTICIPATOR	LPCO	LOW PRESSURE CUTOUT SW.
CBS	COIL BOTTOM SENSOR	MS	COMPRESSOR MOTOR CONTACTOR
CF	FAN CAPACITOR	ODA	OUTDOOR ANTICIPATOR
CN	WIRE CONNECTOR	OFT	OUTDOOR FAN THERMOSTAT
CPR	COMPRESSOR	ODS	OUTDOOR TEMPERATURE SENSOR
CR	RUN CAPACITOR	ODT	OUTDOOR THERMOSTAT
CS	STARTING CAPACITOR	RHS	RESISTANCE HEAT SWITCH
CSR	CAPACITOR SWITCHING RELAY	SC	SWITCHOVER VALVE SOLENOID
DFC	DEFROST CONTROL	SM	SYSTEM "ON-OFF" SWITCH
F	INDOOR FAN RELAY	TDL	DISCHARGE LINE THERMOSTAT
HA	HEATING ANTICIPATOR	TNS	TRANSFORMER
HPCO	HIGH PRESSURE CUTOUT SW.	TS	HEATING-COOLING THERMOSTAT
IOL	INTERNAL OVERLOAD PROTECTOR	TSH	HEATING THERMOSTAT



# Dimensions

## 4TTZ0 Outline Drawing

Note: All dimensions are in MM (Inches).

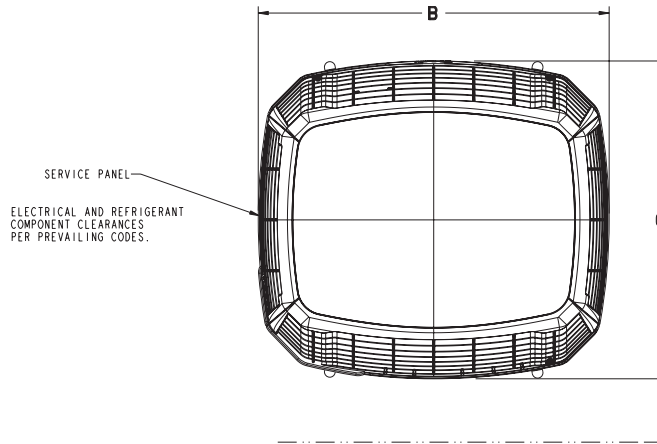

UNIT SHOULD BE PLACED SO ROOF RUN-OFF WATER DOES NOT POUR DIRECTLY ON UNIT, AND SHOULD BE AT LEAST 305 (12") FROM WALL AND ALL SURROUNDING SHRUBBERY ON TWO SIDES. OTHER TWO SIDES UNRESTRICTED.

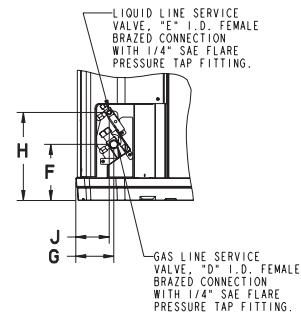
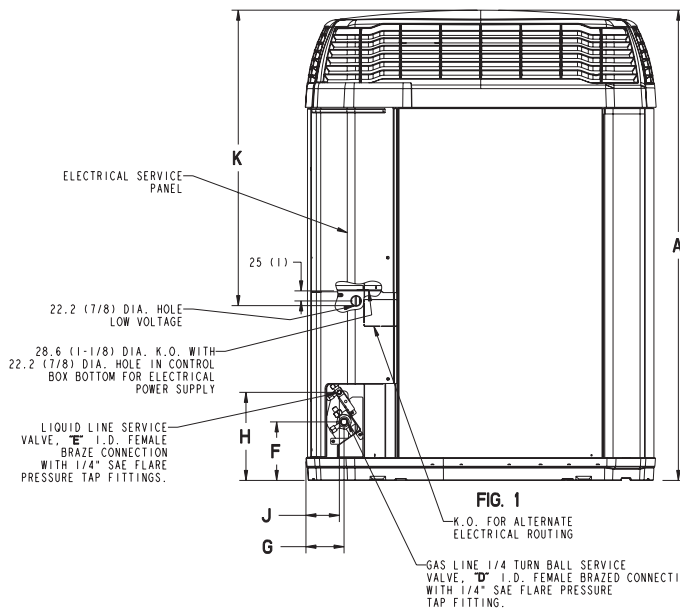

MODELS	BASE	A	B	C	D	E	F	G	H	J	K
4TTZ0024A	4	1369 (53 7/8)	946 (37-1/4)	870 (34-1/4)	5/8	3/8	152 (6)	98 (3-7/8)	219 (8-5/8)	86 (3-3/8)	1035 (40 3/4)
4TTZ0036A 4TTZ0048A 4TTZ0060A	4	1369 (53 7/8)	946 (37-1/4)	870 (34-1/4)	3/4	3/8	152 (6)	98 (3-7/8)	219 (8-5/8)	86 (3-3/8)	1035 (40 3/4)

From Dwg. D152635 Rev. 15

# Mechanical Specification Options

---

## General

The 4TTZ0 is fully charged from the factory for matched indoor section and up to 15 feet of piping. This unit is designed to operate at outdoor ambient temperatures as high as 115°F. Cooling capacities are matched with a wide selection of air handlers and furnace coils that are A.R.I. certified. The unit is UL listed. Exterior is designed for outdoor application.

## ComfortLink™ II

This outdoor unit contains the ComfortLink™ II digital communication with 2 wire connection to outdoor and Plug-n-Play set up.

## Charge Assist™

The Charge Assist™ indicates system Charge Status.

## Casing

Unit casing is constructed of heavy gauge, G60 galvanized steel and painted with a weather-resistant powder paint on all louvers, panels, prepaint on all other panels. Corrosion and weather-proof CMBP-G30 DuraTuff™ base.

## Refrigerant Controls

Refrigeration system controls include condenser fan, compressor contactor and high and low pressure switches. High and low pressure controls are inherent to the compressor. A factory installed liquid line drier is standard.

## Compressor

The Climatuff® compressor features a 10 year limited warranty, internal over

temperature and pressure protection and total dipped hermetic motor. Other features include: roto lock suction and discharge refrigerant connections, centrifugal oil pump and low vibration and noise.

## Condenser Coil

The outdoor coil provides low airflow resistance and efficient heat transfer. The coil is protected on all four sides by louvered panels and has a 10 year limited warranty.

## Low Ambient Cooling

As manufactured, this unit has a cooling capability to 55°F. For low ambient cooling below 55° see Application Guide SSC-APG005-EN.

## Comfort Control

ComfortLink™ II Control with Plug-n-Play set up and 3 wire connection.



**ARI Standard**  
**210/240 UAC**





Trane  
[www.trane.com](http://www.trane.com)

---

---

---

---

10/08

*Trane has a policy of continuous product and product data improvement and it reserves the right to change design and specifications without notice.*